

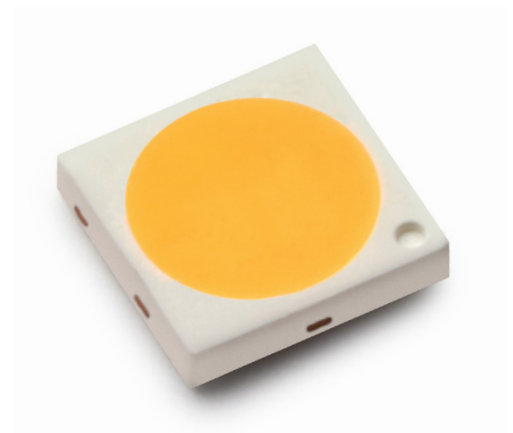

# LUXEON 3030 2D

## High flux, hot-color targeted 6V package

LUXEON 3030 2D is the first hot-color targeted mid power LED. Hot-color targeting ensures that the LEDs are within color target at application conditions—85°C. Using an industry standard packaging of 3.0mm x 3.0mm x 0.5mm and 6V surface-mount emitter solution, LUXEON 3030 2D comes in all ANSI CCTs and delivers the efficacy and reliability required for indoor illumination markets.



### FEATURES AND BENEFITS

Industry standard package enables drop-in replacement for existing 3030 packages

1/9<sup>th</sup> micro-color binning enables tight color control

Superior luminous flux at max current for reduced LED count

Hot-color targeting ensures that color is within ANSI bin at typical application conditions, 85°C

Enables 3-, 4-, 5-step MacAdam ellipse custom binning kits

### PRIMARY APPLICATIONS

Downlights

High Bay & Low Bay

Lamps

Outdoor

# Table of Contents

<b>General Product Information</b> .....	<b>2</b>
Product Test Conditions .....	2
Part Number Nomenclature .....	2
Lumen Maintenance .....	2
Environmental Compliance .....	2
<b>Performance Characteristics</b> .....	<b>3</b>
Product Selection Guide .....	3
Optical Characteristics .....	3
Electrical and Thermal Characteristics .....	4
<b>Absolute Maximum Ratings</b> .....	<b>4</b>
<b>Characteristics Curves</b> .....	<b>5</b>
Spectral Power Distribution Characteristics .....	5
Light Output Characteristics .....	6
Forward Current Characteristics .....	7
Radiation Pattern Characteristics .....	8
<b>Product Bin and Labeling Definitions</b> .....	<b>9</b>
Decoding Product Bin Labeling .....	9
Luminous Flux Bins .....	9
Color Bin Definition .....	10
Forward Voltage Bins .....	14
<b>Mechanical Dimensions</b> .....	<b>15</b>
<b>Reflow Soldering Guidelines</b> .....	<b>16</b>
JEDEC Moisture Sensitivity .....	16
Solder Pad Design .....	17
<b>Packaging Information</b> .....	<b>17</b>
Pocket Tape Dimensions .....	17
Reel Dimensions .....	18

# General Product Information

## Product Test Conditions

LUXEON 3030 2D LEDs are tested with a 20ms monopulse of 120mA at a junction temperature,  $T_j$ , of 25°C. Forward voltage and luminous flux are binned at a  $T_j$  of 25°C, while color is hot targeted at a  $T_j$  of 85°C.

## Part Number Nomenclature

Part numbers for LUXEON 3030 2D follow the convention below:

L 1 3 0 – **A A B B** 0 0 3 0 0 0 W 2 **C**

Where:

- A A** – designates nominal CCT (22=2200K, 27=2700K, 30=3000K, 35=3500K, 40=4000K, 50=5000K, 57=5700K, 65=6500K)
- B B** – designates minimum CRI (70=70CRI, 80=80CRI and 90=90CRI)
- C** – designates Lumileds internal code (1, 2, 3, etc.=shares the same base part)

Therefore, the following part number is used for a LUXEON 3030 2D 3000K 80CRI:

L 1 3 0 – **3 0 8 0** 0 0 3 0 0 0 W 2 **1**

## Lumen Maintenance

Please contact your local Sales Representative or Lumileds Technical Solutions Manager for more information about the long-term performance of this product.

## Environmental Compliance

Lumileds LLC is committed to providing environmentally friendly products to the solid-state lighting market. LUXEON 3030 2D is compliant to the European Union directives on the restriction of hazardous substances in electronic equipment, namely the RoHS Directive 2011/65/EU and REACH Regulation (EC) 1907/2006. Lumileds LLC will not intentionally add the following restricted materials to its products: lead, mercury, cadmium, hexavalent chromium, polybrominated biphenyls (PBB) or polybrominated diphenyl ethers (PBDE).

# Performance Characteristics

## Product Selection Guide

Table 1. Product performance of LUXEON 3030 2D at 120mA and 100mA at specified temperature.

NOMINAL CCT <sup>[1]</sup>	MINIMUM CRI <sup>[2, 3]</sup>	LUMINOUS FLUX <sup>[2, 3]</sup> (lm)		TYPICAL LUMINOUS EFFICACY (lm/W)	TYPICAL LUMINOUS FLUX (lm)	TYPICAL LUMINOUS EFFICACY (lm/W)	PART NUMBER
		MINIMUM	TYPICAL				
		120mA					
3000K	70	98	108	148	92	153	L130-3070003000W21
3500K	70	100	111	152	95	158	L130-3570003000W21
4000K	70	101	116	158	99	165	L130-4070003000W21
5000K	70	101	116	158	99	165	L130-5070003000W21
5700K	70	101	115	157	98	164	L130-5770003000W21
6500K	70	101	115	157	98	164	L130-6570003000W21
2200K	80	80	88	120	75	125	L130-2280003000W21
2700K	80	80	103	141	88	147	L130-2780003000W21
3000K	80	85	106	145	90	150	L130-3080003000W21
3500K	80	85	109	149	93	155	L130-3580003000W21
4000K	80	90	115	157	98	163	L130-4080003000W21
5000K	80	90	115	157	98	163	L130-5080003000W21
5700K	80	90	115	157	98	163	L130-5780003000W21
6500K	80	90	115	157	98	163	L130-6580003000W21
2700K	90	72	84	115	72	119	L130-2790003000W21
3000K	90	75	86	117	73	122	L130-3090003000W21
3500K	90	75	88	120	75	125	L130-3590003000W21
4000K	90	75	92	126	78	131	L130-4090003000W21
5000K	90	75	92	126	78	131	L130-5090003000W21

**Notes for Table 1:**

1. Correlated color temperature is hot targeted at  $T_j=85^\circ\text{C}$ .
2. Luminous flux and CRI are specified at  $T_j=25^\circ$ . Typical CRI is approximately 2 points higher than the minimum CRI specified, but this is not guaranteed.
3. Lumileds maintains a tolerance of  $\pm 2$  on CRI and  $\pm 7.5\%$  on luminous flux measurements.

## Optical Characteristics

Table 2. Optical characteristics for LUXEON 3030 2D at 120mA,  $T_j=25^\circ\text{C}$ .

PART NUMBER	TYPICAL TOTAL INCLUDED ANGLE <sup>[1]</sup>	TYPICAL VIEWING ANGLE <sup>[2]</sup>
L130-xxxx003000W21	140°	116°

**Notes for Table 2:**

1. Total angle at which 90% of total luminous flux is captured.
2. Viewing angle is the off axis angle from lamp centerline where the luminous intensity is  $\frac{1}{2}$  of the peak value.

# Electrical and Thermal Characteristics

Table 3. Electrical and thermal characteristics for LUXEON 3030 2D at 120mA, T<sub>j</sub>=25°C.

PART NUMBER	FORWARD VOLTAGE <sup>[1]</sup> (V <sub>f</sub> )			TYPICAL TEMPERATURE COEFFICIENT OF FORWARD VOLTAGE <sup>[2]</sup> (mV/°C)	TYPICAL THERMAL RESISTANCE—JUNCTION TO SOLDER PAD (°C/W)
	MINIMUM	TYPICAL	MAXIMUM		
L130-xxxx003000W21	5.8	6.1	6.6	-2.0 to -4.0	12.0

**Notes for Table 3:**

1. Lumileds maintains a tolerance of ±0.1V on forward voltage measurements.
2. Measured between T<sub>j</sub>=25°C and T<sub>j</sub>=85°C.

## Absolute Maximum Ratings

Table 4. Absolute maximum ratings for LUXEON 3030 2D.

PARAMETER	MAXIMUM PERFORMANCE
DC Forward Current <sup>[1]</sup>	240mA
Peak Pulsed Forward Current <sup>[2]</sup>	300mA
ESD Sensitivity (ANSI/ESDA/JEDEC JS-001-2012)	Class 2
LED Junction Temperature (DC & Pulse)	125°C
Operating Case Temperature	-40°C to 105°C
LED Storage Temperature	-40°C to 105°C
Soldering Temperature	JEDEC 020D 260°C
Allowable Reflow Cycles	3
Reverse Voltage (V <sub>reverse</sub> ) <sup>[3]</sup>	-5V

**Notes for Table 4:**

1. Residual periodic variations due to power conversion from alternating current (AC) to direct current (DC), also called "ripple", are acceptable if the following conditions are met:
  - The frequency of the ripple current is 100Hz or higher
  - The average current for each cycle does not exceed the maximum allowable DC forward current
  - The maximum amplitude of the ripple does not exceed 25% of the maximum allowable DC forward current.
2. Pulse operation with the maximum peak pulse forward current is acceptable if the pulse on time is ≤5ms per cycle and the duty cycle is ≤50%
3. At a maximum reverse current of 10µA. LUXEON 3030 2D LEDs are not designed to be driven in reverse bias.

# Characteristics Curves

## Spectral Power Distribution Characteristics

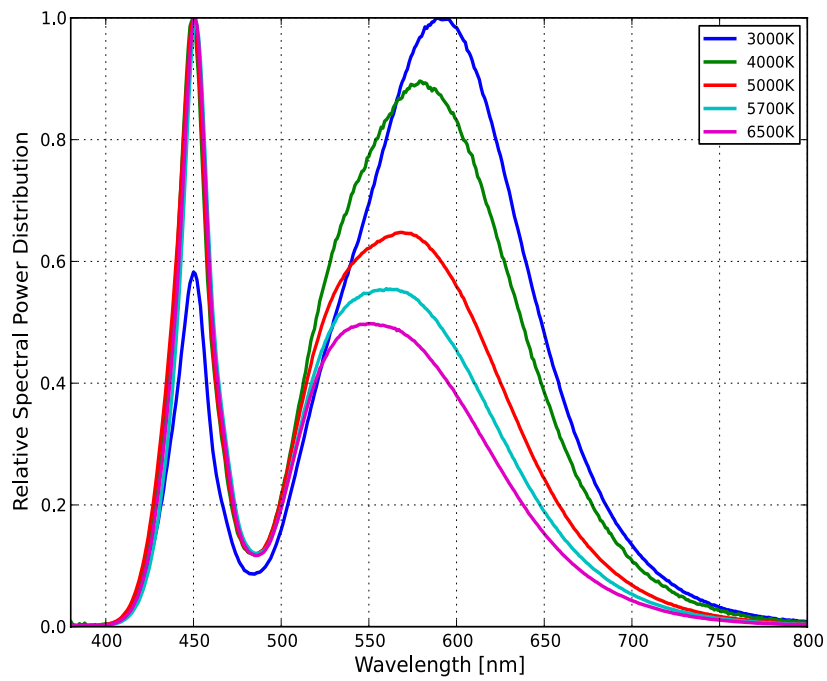

Figure 1a. Typical normalized power vs. wavelength for L130-xx70003000W21 at 120mA,  $T_j=25^{\circ}\text{C}$ .

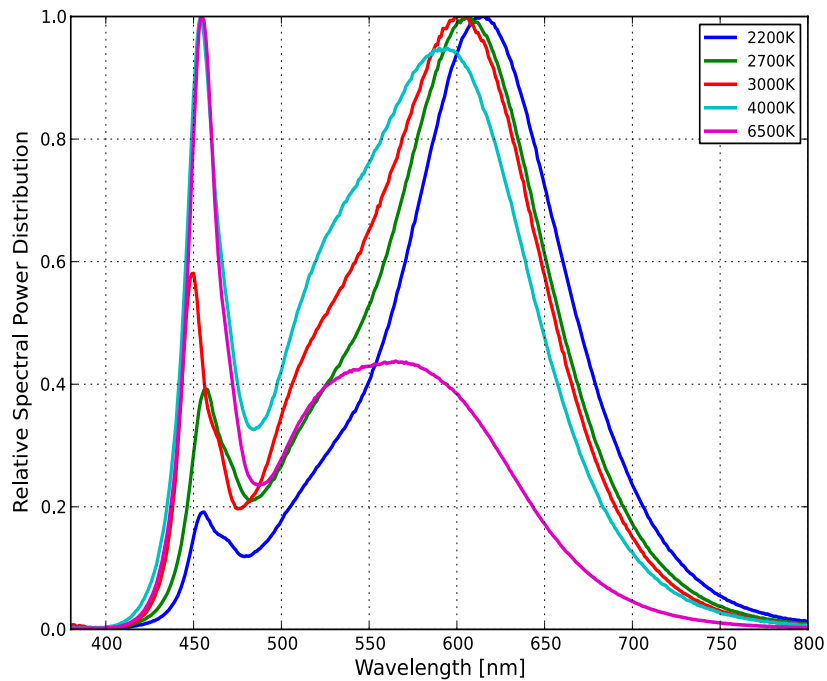

Figure 1b. Typical normalized power vs. wavelength for L130-xx80003000W21 120mA,  $T_j=25^{\circ}\text{C}$ .

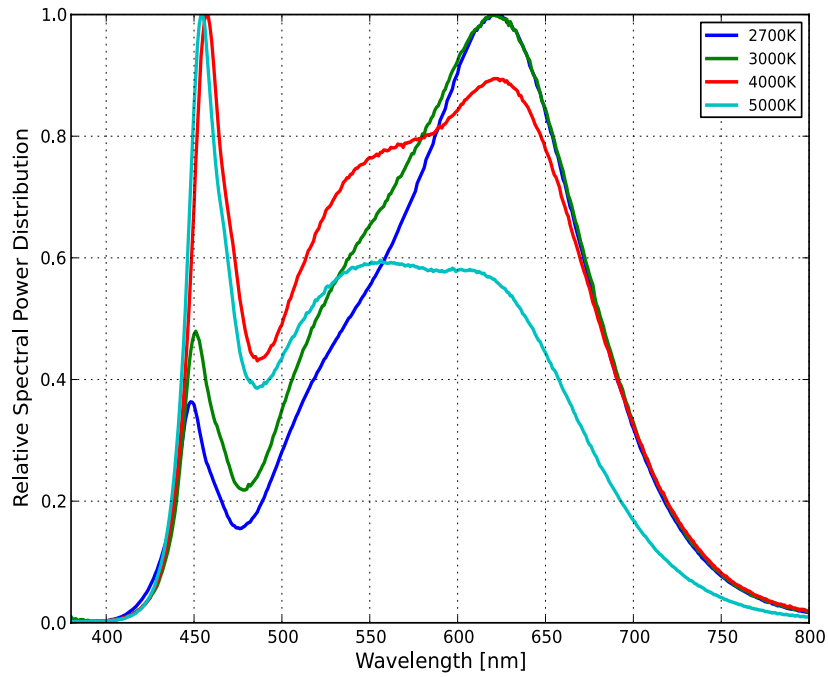

Figure 1c. Typical normalized power vs. wavelength for L130-xx90003000W21 120mA,  $T_j=25^\circ\text{C}$ .

## Light Output Characteristics

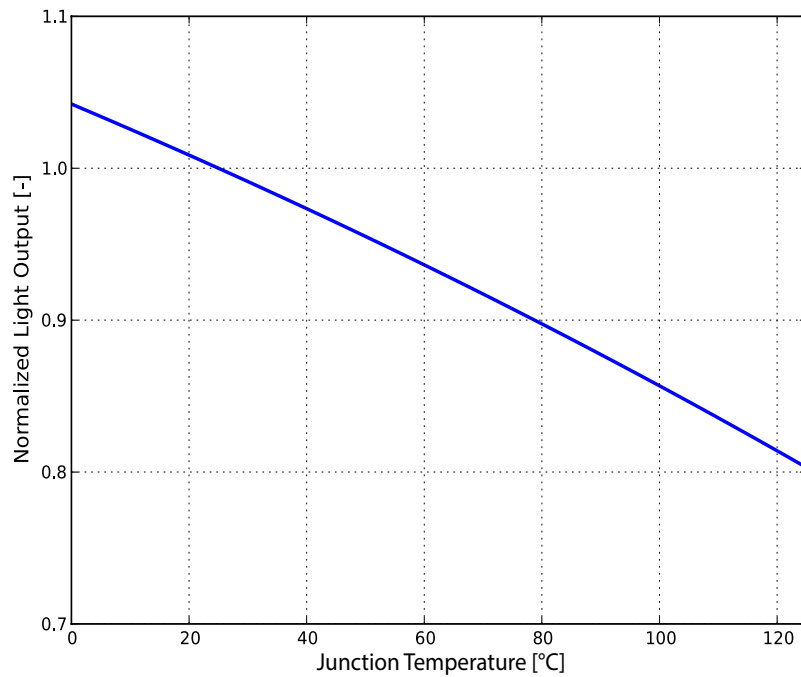
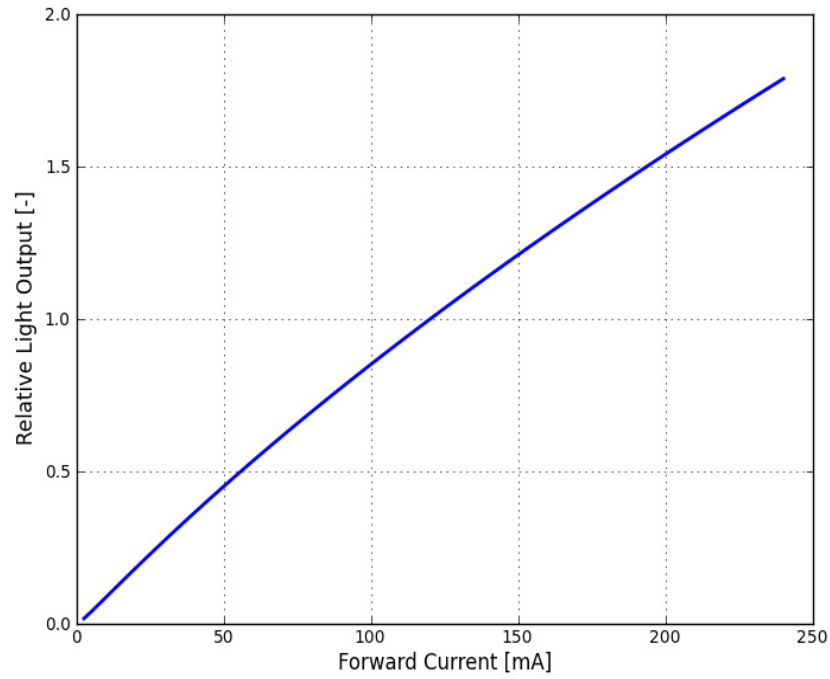

Figure 2. Typical normalized light output vs. junction temperature for L130-xxxx003000W21 at 120mA.



ESTIMATED TYPICAL RATIO COMPARED TO FLUX AT RATED CONDITION 120mA,  $T_j=25^\circ\text{C}$ .

60mA	65mA	100mA	150mA	200mA
53%	57%	85%	121%	154%

Figure 3. Typical normalized light output vs. forward current for L130-xxxx003000W21 at  $T_j=25^\circ\text{C}$ .

## Forward Current Characteristics

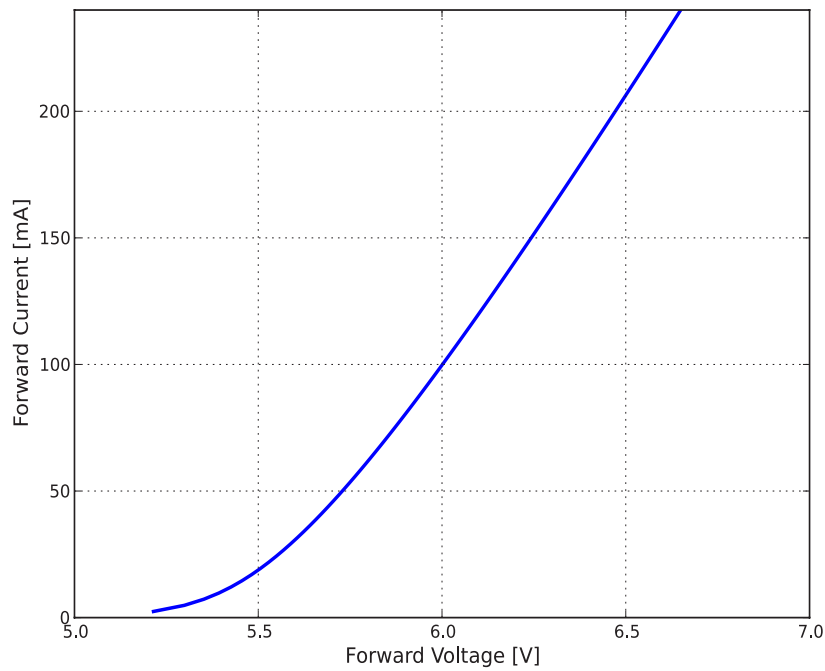

Figure 4. Typical forward current vs. forward voltage for L130-xxxx003000W21 at  $T_j=25^\circ\text{C}$ .



## Radiation Pattern Characteristics

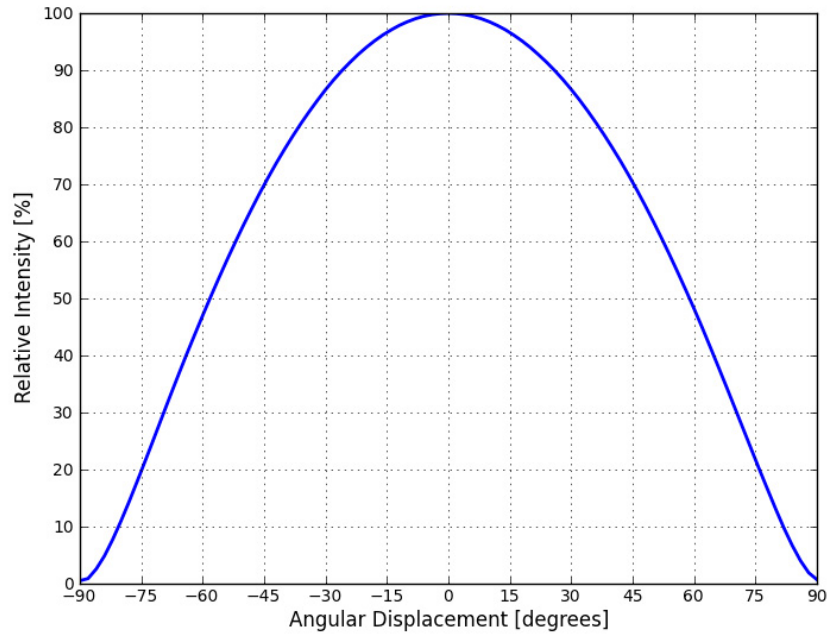

Figure 5. Typical radiation pattern for L130-xxxx003000W21 at 120mA,  $T_j=25^{\circ}\text{C}$ .

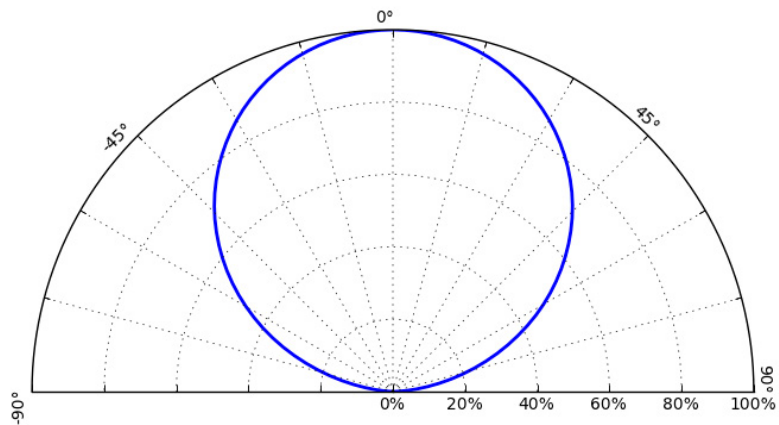

Figure 6. Typical polar radiation pattern for L130-xxxx003000W21 at 120mA,  $T_j=25^{\circ}\text{C}$ .

# Product Bin and Labeling Definitions

## Decoding Product Bin Labeling

In the manufacturing of semiconductor products, there are variations in performance around the average values given in the technical datasheet. For this reason, Lumileds bins LED components for luminous flux or radiometric power, color point, peak or dominant wavelength and forward voltage.

LUXEON 3030 2D LEDs are labeled using a 4-digit alphanumeric CAT code following the format below.

### A B C D

- A** – designates luminous flux bin (ex. H=90 to 95 lumens, M=110 to 115 lumens)
- B C** – designates color bin (ex. 7D, 7E, 7F, 7G, 7H, 7J, 7K, 7L or 7M for 3000K parts)
- D** – designates forward voltage bin (ex. G=5.8 to 6.0V, J=6.2 to 6.4V)

Therefore, a LUXEON 3030 2D with a lumen range of 90 to 95, color bin of 7J and forward voltage range of 5.8 to 6.0 has the following CAT code:

### H 7 J G

## Luminous Flux Bins

Table 5 lists the standard luminous flux bins for LUXEON 3030 2D emitters. Although several bins are outlined, product availability in a particular bin varies by production run and by product performance. Not all bins are available in all CCTs.

Table 5. Luminous flux bin definitions for LUXEON 3030 2D at 120mA, T<sub>j</sub>=25°C.

BIN	LUMINOUS FLUX <sup>(1)</sup> (lm)	
	MINIMUM	MAXIMUM
D	70	75
E	75	80
F	80	85
G	85	90
H	90	95
J	95	100
K	100	105
L	105	110
M	110	115
N	115	120
P	120	125
Q	125	130
R	130	135
S	135	140

**Notes for Table 5:**

1. Lumileds maintains a tolerance of ±7.5% on luminous flux measurements.

# Color Bin Definition

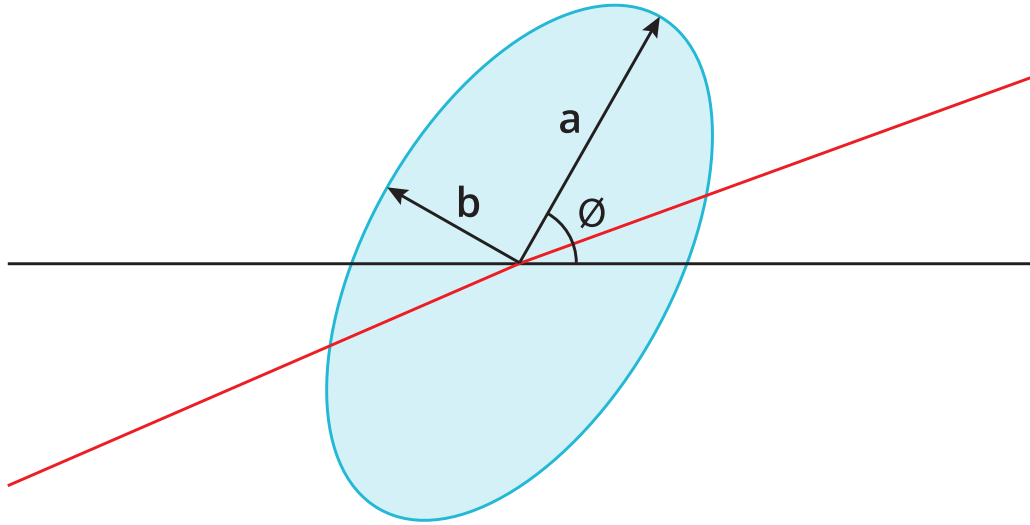

Figure 7. 3- and 5-step MacAdam ellipse illustration for Tables 8a-8h.

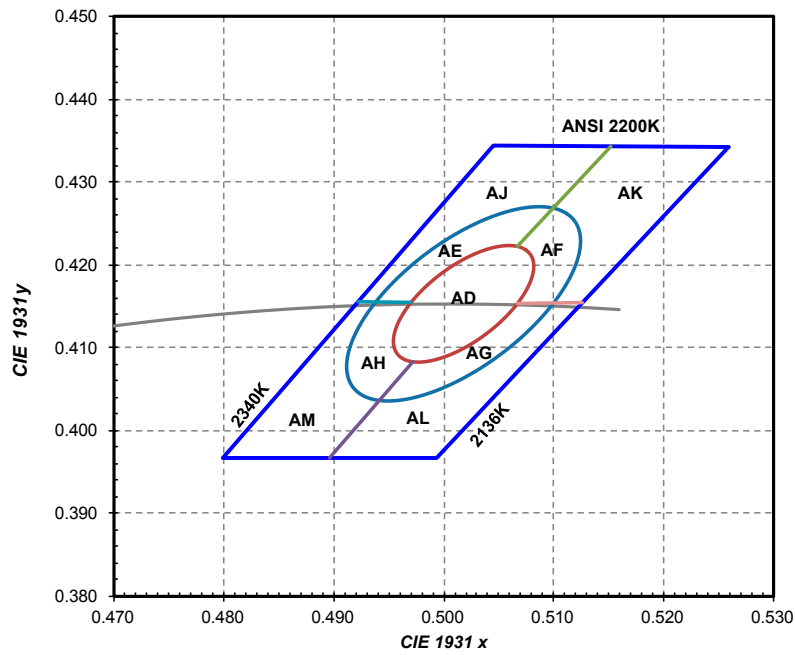

Figure 8a. 1/9<sup>th</sup> color bin structure for LUXEON 3030 2D 2200K, hot-color targeted at 85°C.

Table 6a. 3- and 5-step MacAdam ellipse color bin definitions for L130-22xxxx0030W21 at test current, hot-color targeted at 85°C.

NOMINAL CCT	COLOR SPACE	CENTER POINT <sup>[1]</sup> (cx, cy)	MAJOR AXIS, a	MINOR AXIS, b	ELLIPSE ROTATION ANGLE, $\theta$
2200K	Single 3-step MacAdam ellipse	(0.5018, 0.4153)	0.008625	0.003975	49.27°
2200K	Single 5-step MacAdam ellipse	(0.5018, 0.4153)	0.014375	0.006625	49.27°

Notes for Table 6a:

1. Lumileds maintains a tolerance of  $\pm 0.007$  on x and y color coordinates in the CIE 1931 color space.

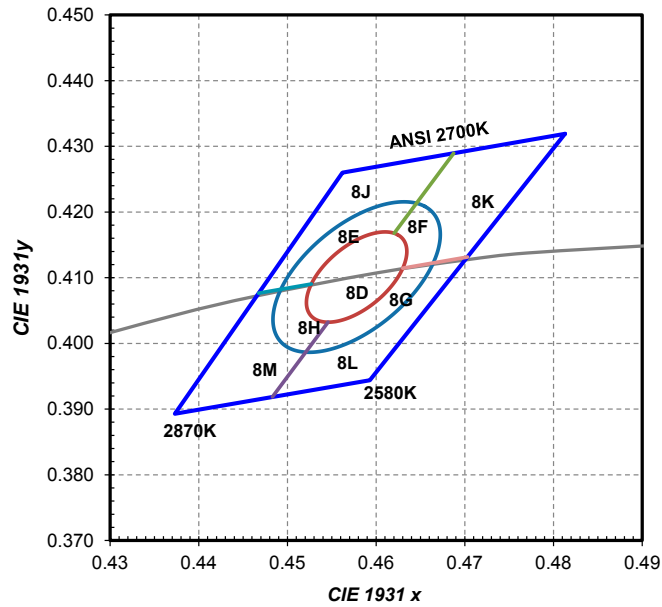

Figure 8b. 1/9<sup>th</sup> color bin structure for LUXEON 3030 2D 2700K, hot-color targeted at 85°C.

Table 6b. 3- and 5-step MacAdam ellipse color bin definitions for L130-27xxxx0030W21 at test current, hot-color targeted at 85°C.

NOMINAL CCT	COLOR SPACE	CENTER POINT <sup>(1)</sup> (cx, cy)	MAJOR AXIS, a	MINOR AXIS, b	ELLIPSE ROTATION ANGLE, $\theta$
2700K	Single 3-step MacAdam ellipse	(0.4578, 0.4101)	0.00810	0.00420	53.70°
2700K	Single 5-step MacAdam ellipse	(0.4578, 0.4101)	0.01350	0.00700	53.70°

Notes for Table 6b:

1. Lumileds maintains a tolerance of  $\pm 0.007$  on x and y color coordinates in the CIE 1931 color space.

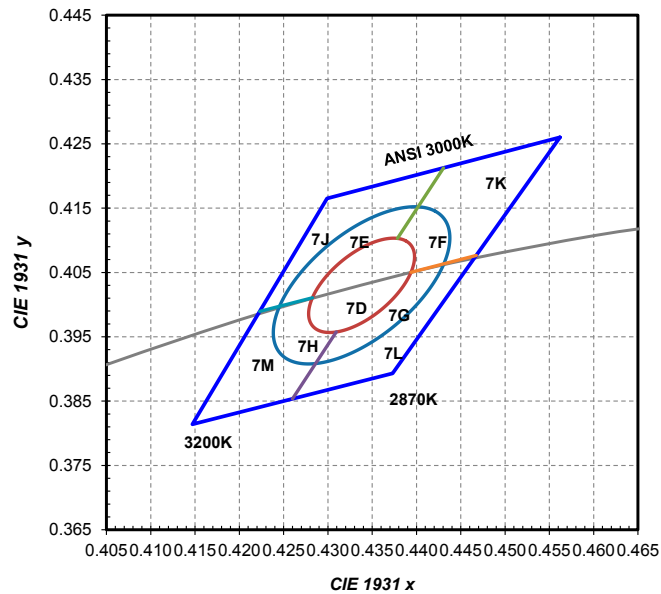

Figure 8c. 1/9<sup>th</sup> color bin structure for LUXEON 3030 2D 3000K, hot-color targeted at 85°C.

Table 6c. 3- and 5-step MacAdam ellipse color bin definitions for L130-30xx003000W21, hot-color targeted at 85°C.

NOMINAL CCT	COLOR SPACE	CENTER POINT <sup>(1)</sup> (cx, cy)	MAJOR AXIS, a	MINOR AXIS, b	ELLIPSE ROTATION ANGLE, $\theta$
3000K	Single 3-step MacAdam ellipse	(0.4338, .04030)	0.00834	0.00408	53.22°
3000K	Single 5-step MacAdam ellipse	(0.4338, .04030)	0.01390	0.00680	53.22°

Notes for Table 6c:

1. Lumileds maintains a tolerance of  $\pm 0.007$  on x and y color coordinates in the CIE 1931 color space.

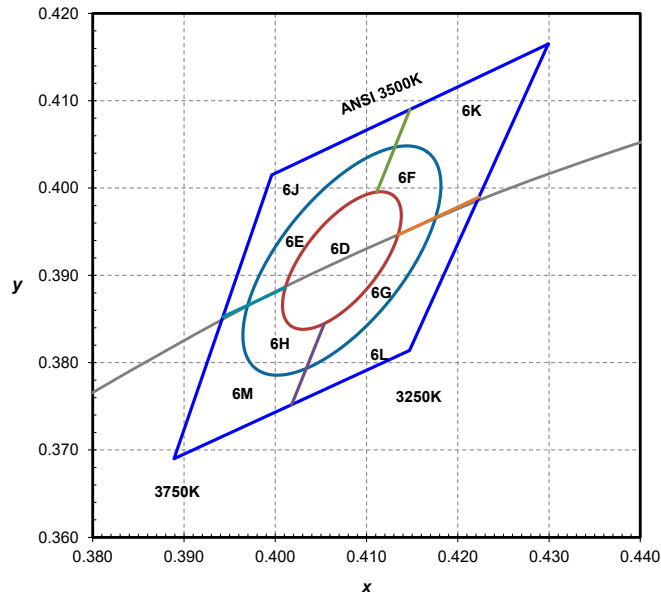

Figure 8d. 1/9<sup>th</sup> color bin structure for LUXEON 3030 2D 3500K, hot-color targeted at 85°C.

Table 6d. 3- and 5-step MacAdam ellipse color bin definitions for L130-35xx003000W21, hot-color targeted at 85°C.

NOMINAL CCT	COLOR SPACE	CENTER POINT <sup>(1)</sup> (cx, cy)	MAJOR AXIS, a	MINOR AXIS, b	ELLIPSE ROTATION ANGLE, $\theta$
3500K	Single 3-step MacAdam ellipse	(0.4073, 0.3917)	0.00927	0.00414	54.00°
3500K	Single 5-step MacAdam ellipse	(0.4073, 0.3917)	0.01545	0.00690	54.00°

Notes for Table 6d:

1. Lumileds maintains a tolerance of  $\pm 0.007$  on x and y color coordinates in the CIE 1931 color space.

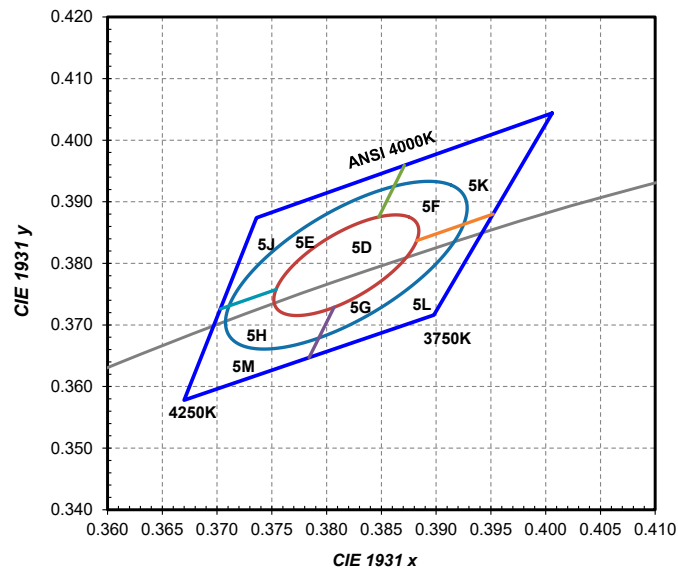

Figure 8e. 1/9<sup>th</sup> color bin structure for LUXEON 3030 2D 4000K, hot-color targeted at 85°C.

Table 6e. 3- and 5-step MacAdam ellipse color bin definitions for L130-40xx003000W21, hot-color targeted at 85°C.

NOMINAL CCT	COLOR SPACE	CENTER POINT <sup>(1)</sup> (cx, cy)	MAJOR AXIS, a	MINOR AXIS, b	ELLIPSE ROTATION ANGLE, $\theta$
4000K	Single 3-step MacAdam ellipse	(0.3818, 0.3797)	0.00939	0.00402	53.72°
4000K	Single 5-step MacAdam ellipse	(0.3818, 0.3797)	0.01565	0.00670	53.72°

Notes for Table 6e:

1. Lumileds maintains a tolerance of  $\pm 0.007$  on x and y color coordinates in the CIE 1931 color space.

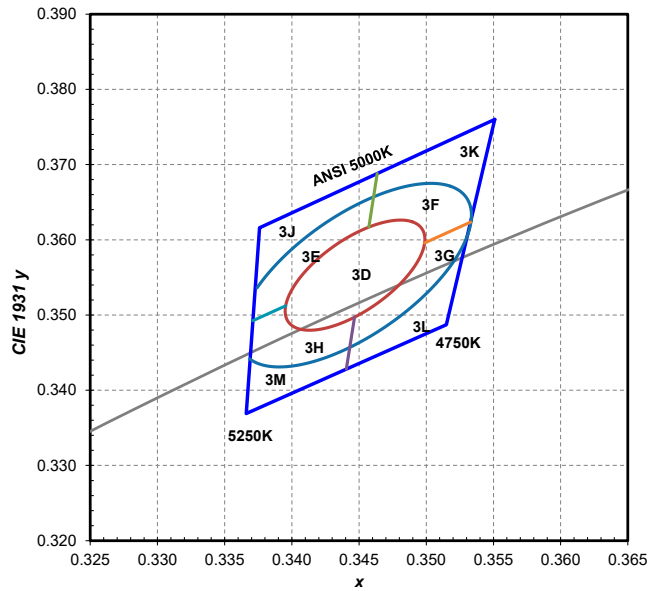

Figure 8f. 1/9<sup>th</sup> color bin structure for LUXEON 3030 2D 5000K, hot-color targeted at 85°C.

Table 6f. 3- and 5-step MacAdam ellipse color bin definitions for L130-50xx003000W21, hot-color targeted at 85°C.

NOMINAL CCT	COLOR SPACE	CENTER POINT <sup>[1]</sup> (cx, cy)	MAJOR AXIS, a	MINOR AXIS, b	ELLIPSE ROTATION ANGLE, $\theta$
5000K	Single 3-step MacAdam ellipse	(0.3447, 0.3553)	0.00822	0.00354	59.62°
5000K	Single 5-step MacAdam ellipse	(0.3447, 0.3553)	0.01370	0.00590	59.62°

Notes for Table 6f:

1. Lumileds maintains a tolerance of  $\pm 0.007$  on x and y color coordinates in the CIE 1931 color space.

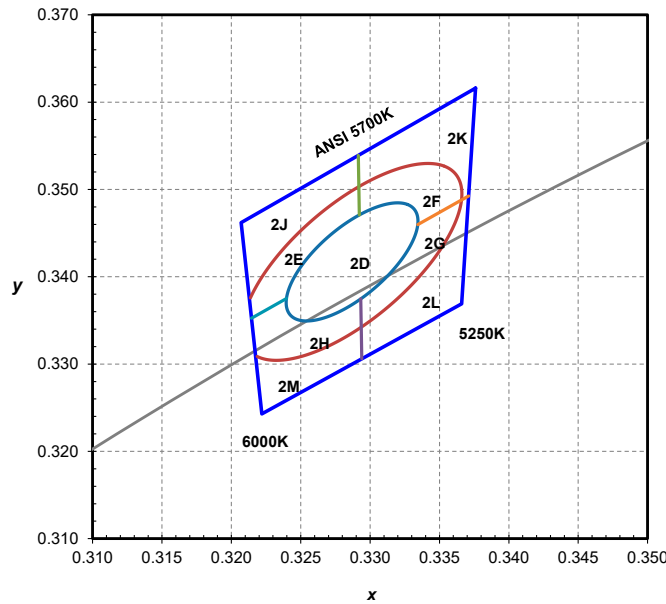

Figure 8g. 1/9<sup>th</sup> color bin structure for LUXEON 3030 2D 5700K, hot-color targeted at 85°C.

Table 6g. 3- and 5-step MacAdam ellipse color bin definitions for L130-57xx003000W21, hot-color targeted at 85°C.

NOMINAL CCT	COLOR SPACE	CENTER POINT <sup>[1]</sup> (cx, cy)	MAJOR AXIS, a	MINOR AXIS, b	ELLIPSE ROTATION ANGLE, $\theta$
5700K	Single 3-step MacAdam ellipse	(0.3287, 0.3417)	0.00746	0.00320	59.09°
5700K	Single 5-step MacAdam ellipse	(0.3287, 0.3417)	0.01243	0.00533	59.09°

Notes for Table 6g:

1. Lumileds maintains a tolerance of  $\pm 0.007$  on x and y color coordinates in the CIE 1931 color space.

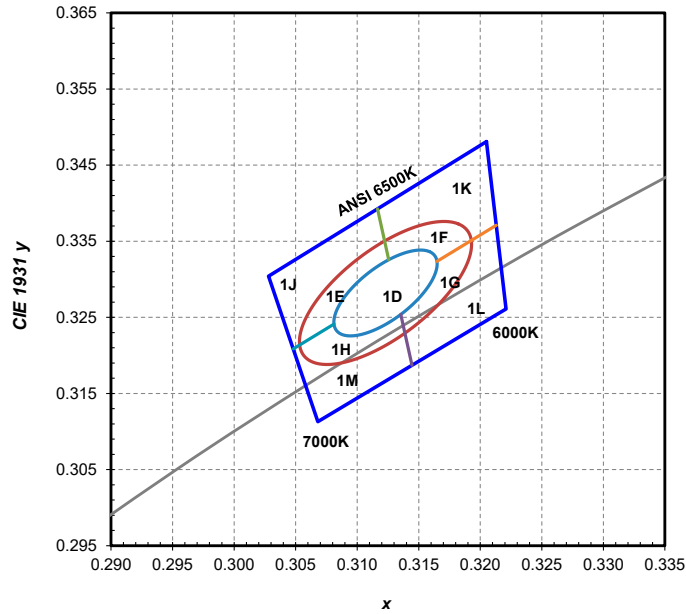

Figure 8h. 1/9<sup>th</sup> color bin structure for LUXEON 3030 2D 6500K, hot-color targeted at 85°C.

Table 6h. 3- and 5-step MacAdam ellipse color bin definitions for L130-65xx003000W21, hot-color targeted at 85°C.

NOMINAL CCT	COLOR SPACE	CENTER POINT <sup>[1]</sup> (cx, cy)	MAJOR AXIS, a	MINOR AXIS, b	ELLIPSE ROTATION ANGLE, $\theta$
6500K	Single 3-step MacAdam ellipse	(0.3123, 0.3282)	0.00669	0.00285	58.57°
6500K	Single 5-step MacAdam ellipse	(0.3123, 0.3282)	0.01115	0.00475	58.57°

Notes for Table 6h:

1. Lumileds maintains a tolerance of  $\pm 0.007$  on x and y color coordinates in the CIE 1931 color space.

## Forward Voltage Bins

Table 7. Forward voltage bin definitions for LUXEON 3030 2D,  $T_j=25^\circ\text{C}$ .

BIN	FORWARD VOLTAGE <sup>[1]</sup> ( $V_f$ )	
	MINIMUM	MAXIMUM
G	5.8	6.0
H	6.0	6.2
J	6.2	6.4
K	6.4	6.6

Notes for Table 7:

1. Lumileds maintains a tolerance of  $\pm 0.1\text{V}$  on forward voltage measurements.

# Mechanical Dimensions

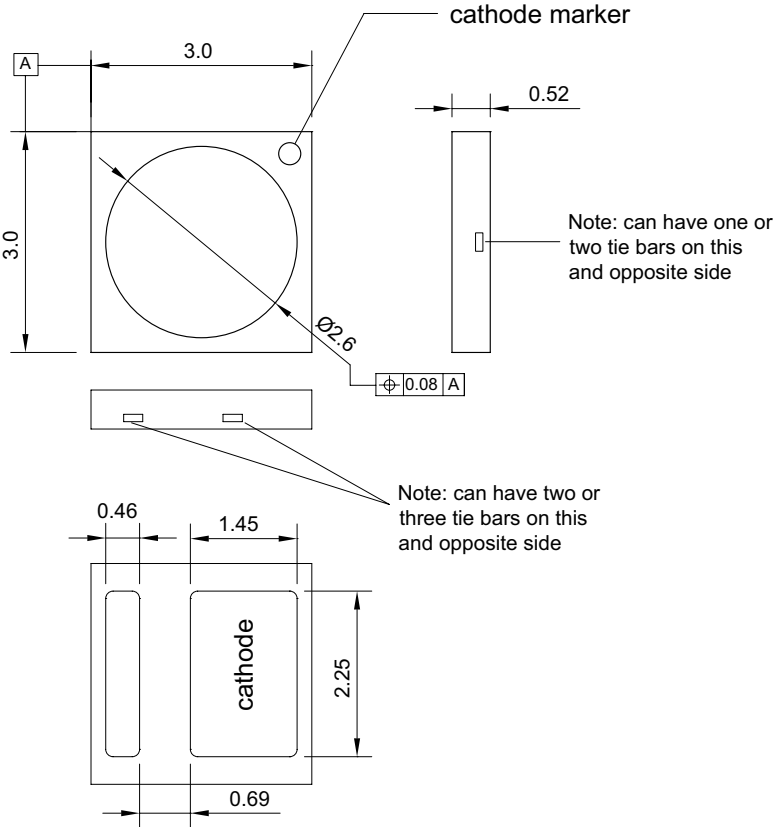

Figure 9. Mechanical dimensions for LUXEON 3030 2D.

- Notes for Figure 9:
1. Drawings are not to scale.
  2. All dimensions are in millimeters.
  3. Tolerance:  $\pm 0.10$ mm.



# Reflow Soldering Guidelines

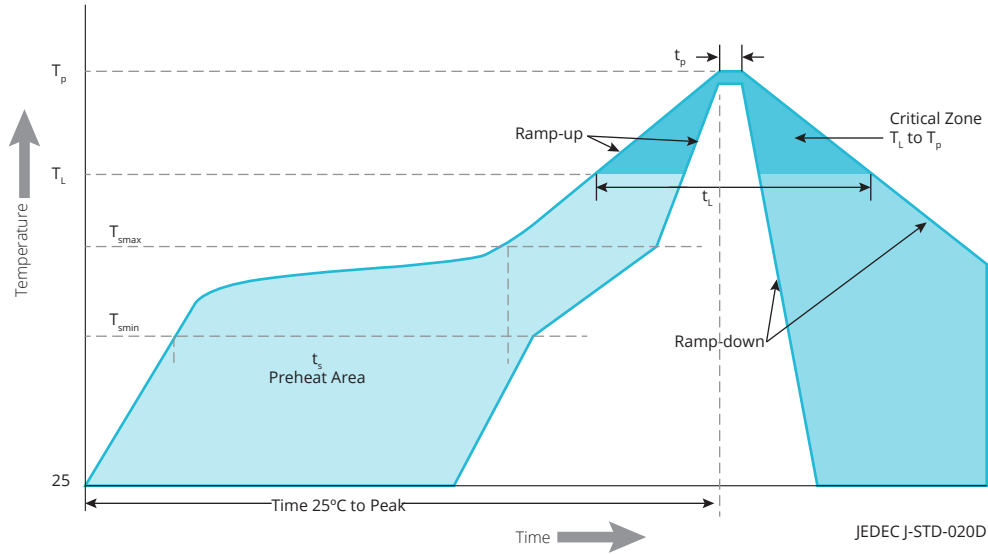

Figure 10. Visualization of the acceptable reflow temperature profile as specified in Table 8.

Table 8. Reflow profile characteristics for LUXEON 3030 2D.

PROFILE FEATURE	LEAD FREE ASSEMBLY
Preheat Minimum Temperature ( $T_{smin}$ )	150°C
Preheat Maximum Temperature ( $T_{smax}$ )	200°C
Preheat Time ( $t_{smin}$ to $t_{smax}$ )	60 to 120 seconds
Ramp-Up Rate ( $T_L$ to $T_p$ )	3°C / second maximum
Liquidus Temperature ( $T_L$ )	217°C
Time Maintained Above Temperature $T_L$ ( $t_L$ )	60 to 150 seconds
Peak / Classification Temperature ( $T_p$ )	260°C
Time Within 5°C of Actual Temperature ( $t_p$ )	20 to 40 seconds
Ramp-Down Rate ( $T_p$ to $T_L$ )	6°C / second maximum
Time 25°C to Peak Temperature	8 minutes maximum

**Notes for Table 8:**

1. All temperatures refer to the application Printed Circuit Board (PCB), measured on the surface adjacent to the package body.

## JEDEC Moisture Sensitivity

Table 9. Moisture sensitivity levels for LUXEON 3030 2D.

LEVEL	FLOOR LIFE		SOAK REQUIREMENTS STANDARD	
	TIME	CONDITIONS	TIME	CONDITIONS
3	168 Hours	30°C / 60% RH	192 Hours +5 / -0	30°C / 60% RH

## Solder Pad Design

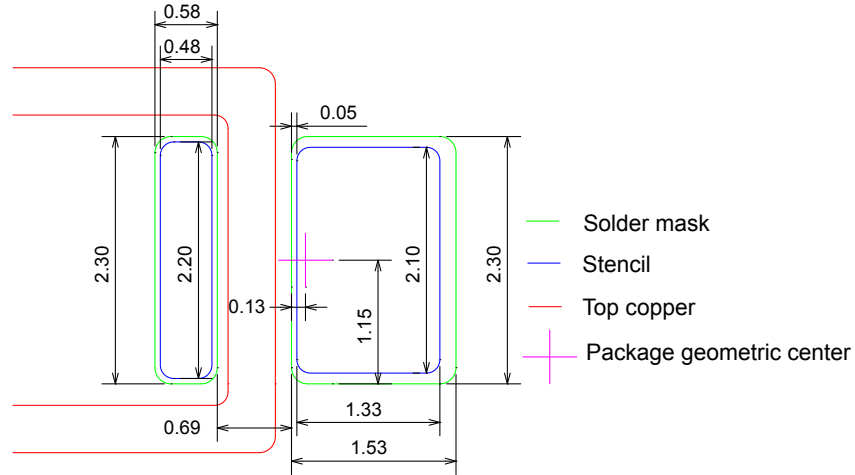

Figure 11. Recommended PCB solder pad layout for LUXEON 3030 2D.

## Packaging Information

### Pocket Tape Dimensions

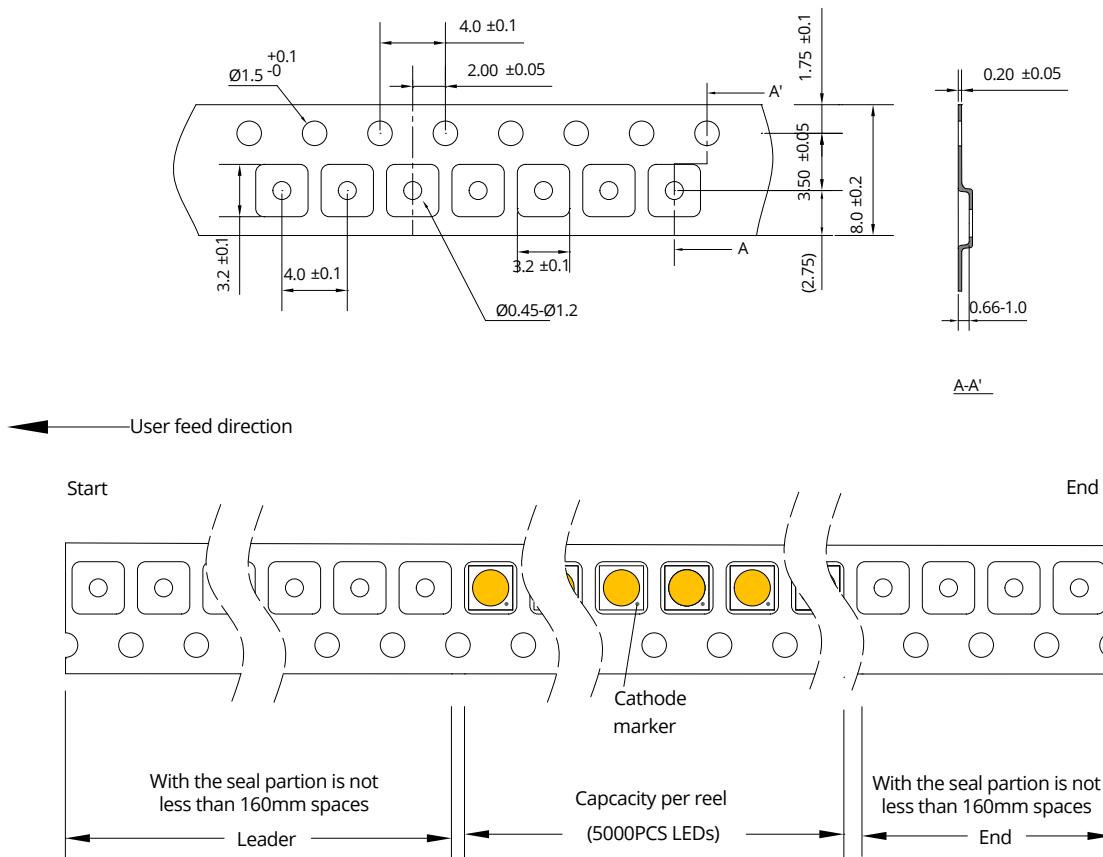

Figure 12. Tape dimensions for LUXEON 3030 2D.

Notes for Figures 11 and 12:  
 1. Drawings are not to scale.  
 2. All dimensions are in millimeters.

# Reel Dimensions

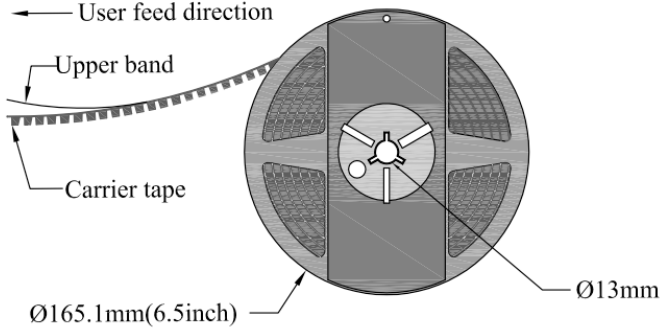

Figure 13. Reel dimensions for LUXEON 3030 2D.

- Notes for Figure 13:
- 1. Drawings are not to scale.
  - 2. All dimensions are in millimeters.

## About Lumileds

Lumileds is the global leader in light engine technology. The company develops, manufactures and distributes groundbreaking LEDs and automotive lighting products that shatter the status quo and help customers gain and maintain a competitive edge.

With a rich history of industry “firsts,” Lumileds is uniquely positioned to deliver lighting advancements well into the future by maintaining an unwavering focus on quality, innovation and reliability.

To learn more about our portfolio of light engines, visit [lumileds.com](http://lumileds.com).



©2017 Lumileds Holding B.V. All rights reserved.  
LUXEON is a registered trademark of the Lumileds Holding B.V.  
in the United States and other countries.

[lumileds.com](http://lumileds.com)

Neither Lumileds Holding B.V. nor its affiliates shall be liable for any kind of loss of data or any other damages, direct, indirect or consequential, resulting from the use of the provided information and data. Although Lumileds Holding B.V. and/or its affiliates have attempted to provide the most accurate information and data, the materials and services information and data are provided “as is,” and neither Lumileds Holding B.V. nor its affiliates warrants or guarantees the contents and correctness of the provided information and data. Lumileds Holding B.V. and its affiliates reserve the right to make changes without notice. You as user agree to this disclaimer and user agreement with the download or use of the provided materials, information and data.